



Switch Disconnector/Switch Disconnecter Fuse,  
HRC Fuse/Fuse Base

Power Switching





Indo Asian has always stressed on providing innovative and high quality products to meet customer demand. With breakthrough products backed by motivation and insight, Indo Asian has risen to be a lead player in the field of Low Voltage Switchgear products.

Indo Asian range of Switch Disconnecting Fuses (SDF), HRC Fuses and Fuse Bases not only meet, but surpass all international and national standards.

SDF offering of Indo Asian contains a number of unique features which provide many advantages to the customers, most notably the QUAD break principle which enables a drastic reduction in arcing while opening & closing of the contact.

HRC fuses present a number of features such as low watt loss enabling longer life and very high breaking capacity. To sum it up, Indo Asian SDFs and HRC Fuses are an epitome of reliable, safe, simple and versatile solution.

## Construction and Features

### ■ Innovative Design :

- The design of SDF units type IN1 is based on the innovative 'QUAD BREAK' principle. This design enables a drastic reduction in the intensity of arc, which is produced at the time of breaking. During breaking the current path is broken at four places in series, thus the arc is reduced. This leads to less strain on the contacts and the life of the switch is increased.
- The moving contacts are designed to make two parallel current paths, which produce high electro-magnetic attraction forces during high faults and increase the contact pressure, this eliminates chance of arcing at the contacts and allows the fuse to safely clear the fault. The self-cleaning contacts ensure wiping of deposits during each operation and increase the life of the contacts. Telescopic shaft feature enables the operating shaft extension upto 25mm.

### ■ Complete Safety :

- The fuses in SDF units' type IN1 are stationary and are isolated at both the incoming and outgoing ends, this offers complete safety for fuse replacement in OFF condition.
- The switch mechanism is quick-make quick-break i.e. independent of operating speed. Positive ON/OFF indication is provided at the switch handle and mechanism assembly; however, clear physical contact position can be seen through inspection windows on the housing of the switch.
- The complete range from 32A to 800A is offered in TPN and 4-pole (TPSN) versions. In case of switched neutral (TPSN) version, the neutral is advance (i.e. makes before and breaks later than the main poles) and is housed in the same housing without any Add-on attachment.
- Phase barriers are provided as a standard feature to prevent any accidental fault between the fuses.

### Technical Specifications :

- Conforming to IS/IEC 60947 - 3
- Rated insulation voltage: 1000V AC/1500V DC
- High Breaking capacity: AC23A
- Contact position clearly visible through inspection windows
- ON/OFF position clearly indicated on handle and on switch mechanism
- Independent manual operation
- Front operated rotary handle with door interlock
- Padlock Feature
- Telescopic Shaft
- Storage Ambient Temperature : -25°C to 55°C
- Working Ambient Temperature : -20°C to 45°C
- Relative Humidity : Maximum 95%
- Rated frequency : 50/60Hz
- Auxiliary Contacts :
  - 1NO + 1NC
  - 2NO + 2NC



Technical Data (DIN type)

No. of poles		TPN/TPSN		TPN/TPSN			TPN/TPSN		TPN/TPSN		TPN/TPSN	
Rated thermal current (I <sub>th</sub> )	A	32	63	100	125	160	200	250	315	400	630	800
Rated operational voltage (U <sub>e</sub> )	V	415	415	415	415	415	415	415	415	415	415	415
Rated insulation voltage (U <sub>i</sub> )	V	1000	1000	1000	1000	1000	1000	1000	1000	1000	1000	1000
Rated impulse withstand voltage (U <sub>imp</sub> )	kV	8	8	12	12	12	12	12	12	12	12	12
Rated frequency	Hz	50-60	50-60	50-60	50-60	50-60	50-60	50-60	50-60	50-60	50-60	50-60
Conventional enclosed thermal current at 45°C (I <sub>the</sub> )	A	32	63	100	125	160	200	250	315	400	630	800
Rated operational current (I <sub>e</sub> ) (A) AC-21A utilization category at 415V AC-22A utilization category at 415V AC-23A utilization category at 415V	A	32	63	100	125	160	200	250	315	400	630	800
	A	32	63	100	125	160	200	250	315	400	630	800
	A	32	63	100	125	160	200	250	315	400	630	800
Rated making capacity (415V, Cosφ=0.35) (0.45*)	A	320*	630*	1000	1250	1600	2000	2500	3150	4000	6300	8000
Rated breaking capacity (415V, Cosφ=0.35) (0.45*)	A	256*	504*	800	1000	1280	1600	2000	2520	3200	5040	6400
Rated fused short circuit current	kA	80	80	80	80	80	80	80	80	80	80	80
Capacitor duty at 415V, 50-60Hz	kVAR	15	30	45	50	70	90	110	140	180	300	380
Mechanical life (Operating cycles)		10000	10000	10000	8000	8000	7000	7000	7000	7000	4000	4000
Electrical life (Operating cycles)		1500	1500	1500	1000	1000	1000	1000	1000	1000	1000	1000
Terminal size mm	Phase	12x2	12x2	16x4	16x4	16x4	25x4	25x4	30x5	30x5	40x7	40x7
	TPSN Neutral	15x3	15x3	16x4	16x4	16x4	28x4	28x4	40x6	40x6	50x7	50x7
	TPN Neutral	12x1.6	12x2	16x3	16x3	16x3	25x3	25x3	30x3	30x3	50x4	50x4
Terminal capacity	mm <sup>2</sup>	25	25	50	70	95	185	185	2x300	2x300	2x400	2x400
Details of IA Fuses Suitable for Switch Disconnecter Fuse Unit Type designation of fuse		SIZE 000	SIZE 000	SIZE 00	SIZE 00	SIZE 00	SIZE 1	SIZE 1	SIZE 2	SIZE 2	SIZE 3	SIZE 3
Size of fuse as per IS-13703 (Part I & II) / IEC 60269		SIZE 000	SIZE 000	SIZE 00	SIZE 00	SIZE 00	SIZE 1	SIZE 1	SIZE 2	SIZE 2	SIZE 3	SIZE 3
Ratings of Indo Asian make fuses available	A	6-32	6-63	6-100	6-125	6-160	32-200	32-250	250-400	250-400	315-630	800

ORDER REFERENCE	IT1F		IT2F		IT3F			IT4F		IT5F	
	32A	63A	100A	125A	160A	200A	250A	315A	400A	630A	800A
Interior TPN	IN10A032	IN10A063	IN10A100	IN10A125	IN10A160	IN10A200	IN10A250	IN10A315	IN10A400	IN10A630	IN10A800
Interior TPSN	IN10B032	IN10B063	IN10B100	IN10B125	IN10B160	IN10B200	IN10B250	IN10B315	IN10B400	IN10B630	IN10B800
In sheet steel enclosure TPN	IN1SA032	IN1SA063	IN1SA100	IN1SA125	IN1SA160	IN1SA200	IN1SA250	IN1SA315	IN1SA400	IN1SA630	IN1SA800
In sheet steel enclosure TPSN	IN1SB032	IN1SB063	IN1SB100	IN1SB125	IN1SB160	IN1SB200	IN1SB250	IN1SB315	IN1SB400	IN1SB630	IN1SB800
Weight Interior (Kg)	1.1	1.1	2	2	5.3	5.3	5.3	7.4	7.4	14.5	14.5

Technical Data (BS type)

No. of poles	TPN/TPSN		TPN/TPSN			TPN/TPSN		TPN/TPSN		
Rated thermal current (I <sub>th</sub> )	A	32	63	100	125	160	200	250	315	400
Rated operational voltage (U <sub>e</sub> )	V	415	415	415	415	415	415	415	415	415
Rated insulation voltage (U <sub>i</sub> )	V	1000	1000	1000	1000	1000	1000	1000	1000	1000
Rated impulse withstand voltage (U <sub>imp</sub> )	kV	8	8	12	12	12	12	12	12	12
Rated frequency	Hz	50-60	50-60	50-60	50-60	50-60	50-60	50-60	50-60	50-60
Conventional enclosed thermal current at 45°C (I <sub>the</sub> )	A	32	63	100	125	160	200	250	315	400
Rated operational current (I <sub>e</sub> ) (A) AC-21A utilization category at 415V AC-22A utilization category at 415V AC-23A utilization category at 415V	A	32	63	100	125	160	200	250	315	400
	A	32	63	100	125	160	200	250	315	400
	A	32	63	100	125	160	200	250	315	400
Rated making capacity (415V, Cosφ=0.35) (0.45*)	A	320*	630*	1000	1250	1600	2000	2500	3150	4000
Rated breaking capacity (415V, Cosφ=0.35) (0.45*)	A	256*	504*	800	1000	1280	1600	2000	2520	3200
Rated fused short circuit current	kA	80	80	80	80	80	80	80	80	80
Capacitor duty at 415V, 50-60Hz	kVAR	15	30	45	50	70	90	110	140	180
Mechanical life (Operating cycles)		10000	10000	10000	8000	8000	7000	7000	7000	7000
Electrical life (Operating cycles)		1500	1500	1500	1000	1000	1000	1000	1000	1000
Terminal size mm	Phase	12x2	12x2	16x4	16x4	16x4	25x4	25x4	30x5	30x5
	TPSN Neutral	15x3	15x3	16x4	16x4	16x4	28x4	28x4	40x6	40x6
	TPN Neutral	12x1.6	12x2	16x3	16x3	16x3	25x3	25x3	30x3	30x3
Terminal capacity	mm <sup>2</sup>	25	25	50	70	95	185	185	2x300	2x300
Details of IA Fuses Suitable for Switch Disconnecter Fuse Unit Type designation of fuse		FSA	FSS	FSDCP	FSDCP	FSDCP	FSF	FSF	FSK	FMF
Size of fuse as per IS-13703 (Part I & II) / IEC 60269		A2	A3	A4	A4	A4	B2	B2	B3	B4
Ratings of Indo Asian make fuses available	A	4-32	35-63	50-100	50-125	50-160	125-200	125-250	250-315	355-400

ORDER REFERENCE	IT1F		IT2F		IT3F			IT4F	
	32A	63A	100A	125A	160A	200A	250A	315A	400A
Interior TPN	IN01A032	IN01A063	IN01A100	IN01A125	IN01A160	IN01A200	IN01A250	IN01A315	IN01A400
Interior TPSN	IN01B032	IN01B063	IN01B100	IN01B125	IN01B160	IN01B200	IN01B250	IN01B315	IN01B400
In sheet steel enclosure TPN	INS1A032	INS1A063	INS1A100	INS1A125	INS1A160	INS1A200	INS1A250	S1A315	INS1A400
In sheet steel enclosure TPSN	INS1B032	INS1B063	INS1B100	INS1B125	INS1B160	INS1B200	INS1B250	INS1B315	INS1B400
Weight Interior (Kg)	1.1	1.1	2	2	5.3	5.3	5.3	7.4	7.4



### Construction and Features

- Compact in size.
- The quick make - quick break switch mechanism independent of the operating speed.
- The self-wiping contact system allows cleaning of contacts during each operation, calling for lesser maintenance and higher life.
- The terminals are staggered allowing easy termination of aluminium conductors with adequate clearances.
- The neutral is 'early make & late break'
- Telescopic shaft feature enables the operating shaft extension upto 25mm.

### Technical Specifications

- Conforming to IS/IEC 60947 - 3
- Rated insulation voltage : 1000V AC/1500V DC
- High Breaking capacity: AC23A
- High Electrical & Mechanical endurance
- Double break self-wiping contacts
- Contact position clearly visible through inspection windows
- Staggered terminals facilitate easy termination and increased clearances
- 'Early Make & Late Break' neutral closes earlier and opens later than the main poles
- Front operated rotary handle with door interlock
- Padlock Feature
- Telescopic Shaft
- Storage Ambient Temperature : -25°C to 55°C
- Working Ambient Temperature : -20°C to 45°C
- Relative Humidity : Maximum 95%
- Rated frequency : 50/60Hz
- Auxiliary Contacts:
  - 1NO + 1NC
  - 2NO + 2NC





Technical Data

Rating		63A	100A	125A	200A	250A	315A	400A	630A	800A
Rated insulation voltage	(Ui) VAC	1000	1000	1000	1000	1000	1000	1000	1000	1000
	VDC	1500	1500	1500	1500	1500	1500	1500	1500	1500
Rated impulse withstand voltage	(Uimp) kV	8	8	8	12	12	12	12	12	12
Rated thermal current	(Ith) A	63	100	125	200	250	315	400	630	800
Rated operational current (A) (Ie) AC-23A	240V	63	100	125	200	250	315	400	630	800
	415V	63	100	125	200	250	315	400	630	800
	500V	45	80	100	160	200	250	315	500	800
	690V	35	63	80	125	160	200	250	400	400
Short withstand current 1 sec.	kA	5	5	5	8	8	13	13	26.5	35
Making capacity in short circuit	kA	7.5	7.5	7.5	13.5	13.5	26	26	30	73.5
Back-up fuse	A	63	100	125	200	250	315	400	630	800
Rated making capacity 415V AC cos $\theta$ = 0.35(0.45*)	A	630*	1000	1250	2000	2500	3150	4000	6300	8000
Rated breaking capacity 415V AC cos $\theta$ = 0.35(0.45*)	A	504*	800	1000	1600	2000	2520	3200	5040	6400
Capacitor duty 415V AC	kVAR	30	45	50	90	110	140	180	300	380
Mechanical endurance (Operating Cycles)		12000	12000	10000	10000	10000	8000	8000	8000	7000
Electrical endurance (Operating Cycles)		3000	3000	2000	2000	2000	1500	1500	1500	1000
Terminal size	mm	15x3	15x3	15x3	20x4	20x4	28x4	28x4	40x6	50x7
Terminal Capacity	mm <sup>2</sup>	70	70	70	185	185	300	300	400	..
Ordering Code		IN1SD063	IN1SD100	IN1SD125	IN1SD200	IN1SD250	IN1SD315	IN1SD400	IN1SD630	IN1SD800







### Construction and Feature

- Conforming to IEC-60269
- High breaking capacity 80kA to 120kA at 500V AC
- Available with CE marking
- Low Watt Loss, Ensures cool running & longer life
- No de-ration required for connected equipment
- Low let through energy, low cut off characteristics, reduced electro magnetic stress
- Fault indication is immediate. The red pop up indicator comes out instantly on fusing

### Available Range

- Fuse Link for bolted connection (BS Fuse)
- Fuse Link having cylindrical contact cap
- Fuse Link with blade contact (Din Fuse / Knife Type)
- Din Fuse Base
- J type Fuse (Wedge Type)
- BS fuse fittings

### Technical Data

#### BS Fuse

- Conforming to IEC 60269/BS 88
- Rated Current : 2A to 630A
- Rated Voltage : 500V
- Breaking Capacity : 80kA to 120kA
- Rated Frequency : 50/60Hz

#### DIN Fuse (Knife Type)

- Conforming to IEC 60269/DIN 43620
- Range : Size (000,00, 01, 02, 03)
- Rated Current : 6A to 630A
- Rated Voltage : 500V
- Breaking Capacity : 80kA to 120kA
- Rated Frequency: 50/60Hz

#### DIN Fuse Base

- Conforming to IEC 60269/DIN 43620
- Range : Size ( 00, 1, 2, 3)
- Rated Current : 6A to 630A
- Rated Voltage : 500V
- Breaking Capacity : 80kA(with fuse)
- Rated Frequency: 50/60Hz



#### J Type Fuse

- Conforming to IEC 60269/BS 88
- Rated Current : 20A to 400A
- Rated Voltage : 415V
- Breaking Capacity : 80kA
- Rated Frequency: 50/60Hz





#### BS Fuse Fittings

- Conforming to IEC 60269/BS 88
- Rated Current : 20A / 32A / 63A / 100A
- Rated Voltage : 415V





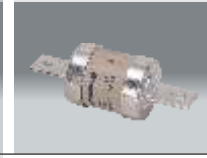

	FGN (F1)		FSA (A2)		FSS (A3)		FSDCP (A4)		FSFP	
<b>REFERENCE</b>										
Voltage Rating	500V AC		500V AC		500V AC		500V AC		500V AC	
Breaking Capacity	80kA		80kA		80kA		80kA		80kA	
Current Ratings /	2A	0.75W	4A	1.1W	35A	4.4W	50A	6.5W	125A	12.8W
Watt Loss	4A	0.95W	6A	1.8W	40A	4.7W	63A	6.7W	160A	16.8W
	6A	1W	10A	1.9W	50A	4.8W	80A	8.8W	200A	20.2W
	8A	1.1W	16A	2.4W	63A	6.2W	100A	8.8W		
	10A	1.2W	20	2.6W			125A	11.8W		
	16A	1.7W	25A	2.7W			160A	13.2W		
	20A	1.8W	32A	3.9W						
	25A	2.5W								
	32A	2.96W								
Extended Motor range	FGN20M25	1.6W	32M35	3.8W	63M80	5.6W	100M125	7.0W		
	FGN20M32	1.4W					100M160	6.0W		
							100M200	5.0W		
<b>Dimensions (mm)*</b>										
Overall Length	60mm		84.5mm		88.5mm		110mm		110mm	
Hole Fixing Centres	-		73mm		73mm		94mm		93.5mm	
Diameter	14.2mm		21.5mm		21.5mm		32mm		39.5mm	
Tag Type	OFFSET		OFFSET		OFFSET		OFFSET		OFFSET	
No. of Hole Fixing	-		2		2		2		2	
<b>Fuse Fittings</b>										
Front Connection	BFF20A		BFF32A		BFF63A		BFF100A			
Busbar Mounting	BFF20A		BFF32A		BFF63A		BFF100A			
<b>Dimensions (mm)*</b>										
Length	81mm		100mm		106mm		132mm			
Width	26mm		32mm		36mm		50mm			
Height	42mm		65mm		72mm		92mm			
Comply with	BS 88/IEC 60269		BS 88/IEC 60269		BS 88/IEC 60269		BS 88/IEC 60269		BS 88/IEC 60269	



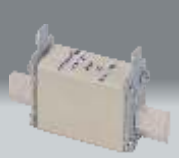

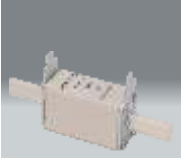
\*Gen. Tol. ± 1.5mm.

	FSDC (B1)	FSF (B2)	FSK (B3)	FMF (B4)	FTM (C2)	FTS
<b>REFERENCE</b>						
Voltage Rating	500V AC	500V AC	500V AC	500V AC	500V AC	500V AC
Breaking Capacity	80kA/120kA (80kA for 125A)	80kA	80kA/120kA	80kA	80kA	80kA
Current Ratings /	50A	125A	250A	355A	400A	400A
Watt Loss	6.6W	14W	23.2W	33.4W	32.8W	29.7W
	63A	160A	300A	400A	500A	450A
	8.3W	20.3W	26.1W	35.1W	37.6W	31.6W
	80A		315A		630A	500A
	9.3W				51W	39W
	125A					630A
	12.4W					45.7W
Extended Motor Range						
<b>Dimensions (mm)*</b>						
Overall Length	135.5mm	132mm	136mm	136mm	207mm	156mm
Hole Fixing Centres	111mm	111mm	111mm	111mm	133mm,184mm	133mm
Diameter	32mm	39.5mm	50.5mm	50.5mm	70.2mm	70mm
Tag Type	CENTRAL	CENTRAL	CENTRAL	CENTRAL	CENTRAL	CENTRAL
No. of Hole Fixing	2	2	2	2	4	2
Comply with	BS 88/IEC 60269	BS 88/IEC 60269	BS 88/IEC 60269	BS 88/IEC 60269	BS 88/IEC 60269	BS 88/IEC 60269

\*Gen. Tol. ± 1.5mm.

	SIZE 000		SIZE 00		SIZE 0		SIZE 1	
<b>REFERENCE</b>								
Voltage Rating	500V AC		500V AC		500V AC		500V AC	
Breaking Capacity	80kA		80kA/100kA		80kA		80kA/120kA	
Current Ratings /	6A	0.9W	4A	1.0W	63A	7W	32A	4.6W
Watt Loss	10A	1.2W	6A	1.0W	100A	10W	36A	5.3W
	16A	2.6W	10A	1.5W			50A	6.7W
	20A	2.7W	16A	2.5W			63A	6.5W
	25A	2.3W	20A	2.6W			80A	9.1W
	32A	3.1W	25A	2.7W			100A	9.8W
	63A	5.7W	32A	3.5W			125A	12.7W
	50A	5W	40A	4.4W			160A	16.5W
			50A	4.7W			200A	19.8W
			63A	6W			250A	21.3W
			80A	6.5W				
			100A	7.4W				
			125A	10.6W				
			160A	11.8W				
Extended Motor Range								
<b>Dimensions (mm)*</b>								
Overall Length	79		78.5		125		135	
Tag	BLADE		BLADE		BLADE		BLADE	
Width	21		29		28		46	
Tag Type	CENTRE		CENTRE		CENTRE		CENTRE	
No. of Hole Fixing								
<b>Fuse Fittings</b>								
Front Connection								
Busbar Mounting								
Comply With	DIN 43620/IEC 60269		DIN 43620/IEC 60269		DIN 43620/IEC 60269		DIN 43620/IEC 60269	



\*Gen. Tol. ± 1.5mm.

	SIZE 1C	SIZE 2	SIZE 2C	SIZE 3
<b>REFERENCE</b>				
Voltage Rating	500V AC	500V AC	500V AC	500V AC
Breaking Capacity	80kA	80kA/120kA	80kA	80kA
Current Ratings /	32A 4.8W	100A 10.5W	100A 11W	315A 24.3W
Watt Loss	36A 5.3W	125A 12.6W	125A 12W	355A 30.0W
	50A 7W	200A 20.6W	160A 16W	400A 32.7W
	63A 7.5W	250A 21.0W	200A 21W	500A 33.8W
	80A 10W	315A 23.8W	250A 24W	630A 43.5W
	100A 11W	400A 28.3W		425A 33W
	125A 13W			
	160A 17W			
Extended Motor Range				
<b>Dimensions (mm)*</b>				
Overall Length	135	150	150	150
Tag	BLADE	BLADE	BLADE	BLADE
Width	29	57	46	72
Tag Type	CENTRE	CENTRE	CENTRE	CENTRE
No. of Hole Fixing				
<b>Fuse Fittings</b>				
Front Connection				
Busbar Mounting				
Comply With	DIN 43620/IEC 60269	DIN 43620/IEC 60269	DIN 43620/IEC 60269	DIN 43620/IEC 60269

\*Gen. Tol. ± 1.5mm.





# Technical Parameters

## Cylindrical Type

	FR-1 (14X51) IFRH		FR-2 (22X58)		FR-3 (30X57)		FR-4 (17X51)	
<b>REFERENCE</b>								
Voltage Rating	415V AC		415V AC		415V AC		415V AC	
Breaking Capacity	80kA		80kA		80kA		80kA	
Current Ratings /	2A	1.2W	10A	1.9W	80A	5.4W	45A	7.2W
Watt Loss	4A	1.3W	20A	2.3W	100A	6.1W	63A	8.3W
	6A	1.4W	25A	2.7W				
	10A	1.6W	32A	3.2W				
	16A	2.1W	40A	3.3W				
	20A	2.3W	50A	4.3W				
	25A	2.8W	45A	5.0W				
	32A	3.4W	60A	5.2W				
	40A	3.5W	63A	5.2W				
	45A	4.1W	80A	5.6W				
	50A	4.4W	100A	6.0W				
	60A	5.3W						
	63A	5.6W						
<b>Dimensions (mm)*</b>								
Length	51		57		57		51	
Diameter	14.3		22		30		17	
Comply with	BS 1361		BS 1361		BS 1361		BS 1361	

\*Gen. Tol. ± 1.5mm.

## 'J' Type HRC Fuse Links

	SMJ 30		SPJ 30		SMJ 31		SPJ 31	
<b>REFERENCE</b>								
Voltage Rating	415V AC		415V AC		415V AC		415V AC	
Breaking Capacity	80kA		80kA		80kA		80kA	
Current Ratings /	20A	2.5W	100A	8.5W	20A	2.4W	100A	8.1W
Watt Loss	32A	3.5W	125A	10.5W	32A	3.2W	125A	10.1W
	40A	3.8W	160A	12.7W	40A	3.4W	160A	13.0W
	50A	5.0W	200A	14.1W	50A	4.8W	200A	15.1W
	63A	6.0W	250A	19.0W	63A	7.2W	250A	18.3W
	80A	7.5W	315A	26.0W	80A	7.6W	315A	23.7W
	100A	8.6W	355A	27.4W	100A	7.8W	355A	26.8W
	125A	9.6W	400A	29.8W	125A	10.0W	400A	30.0W
	160A	12.7W			160A	12.9W		
	200A	15.8W			200A	16.5W		
	250A	18.8W			250A	18.7W		
	315A	25.8W			315A	25.1W		
<b>Dimensions (mm)*</b>								
Length	111		111		127		127	
Diameter	39		50		39		50	
Fixing Centre	82		82		92		92	
Comply with	BS 88		BS 88		BS 88		BS 88	

\*Gen. Tol. ± 1.5mm.



# Technical Parameters

## Order Reference (HRC fuses)

	Rating /Type	Breaking Capacity	2A	4A	6A	8A	10A	16A	20A	25A	32A	35A	36A	40A	45A	50A	
Bolted Type	FGN(F1)	80kA	IEFGN002	IEFGN004	IEFGN006	IEFGN008	IEFGN010	IEFGN016	IEFGN020	IEFGN025	IEFGN032	-	-	-	-	-	
	FSA(A2)	80kA	-	IEFSA004	IEFSA006	-	IEFSA010	IEFSA016	IEFSA020	IEFSA025	IEFSA032	-	-	-	-	-	
	FSS(A3)	80kA	-	-	-	-	-	-	-	-	-	IEFSS035	-	IEFSS040	-	IEFSS050	
	FSDCP(A4)	80kA	-	-	-	-	-	-	-	-	-	-	-	-	-	-	IEDCP050
	FSFP	80kA	-	-	-	-	-	-	-	-	-	-	-	-	-	-	-
	FSDC(B1)	80kA	-	-	-	-	-	-	-	-	-	-	-	-	-	-	IESDC050
	FSDC(B1)	120kA	-	-	-	-	-	-	-	-	-	-	-	-	-	-	IHSDC050
	FSF(B2)	80kA	-	-	-	-	-	-	-	-	-	-	-	-	-	-	-
	FSK(B3)	80kA	-	-	-	-	-	-	-	-	-	-	-	-	-	-	-
	FSK(B3)	120kA	-	-	-	-	-	-	-	-	-	-	-	-	-	-	-
	FMF(B4)	80kA	-	-	-	-	-	-	-	-	-	-	-	-	-	-	-
	FTM(C2)	80kA	-	-	-	-	-	-	-	-	-	-	-	-	-	-	-
	FTS	80kA	-	-	-	-	-	-	-	-	-	-	-	-	-	-	-
DIN Type	Size000	80kA	-	-	IWS00006	-	IWS00010	IWS00016	IWS00020	IWS00025	IWS00032	-	-	-	-	IWS00050	
	Size00	80kA	-	IW000004	IW000006	-	IW000010	IW000016	IW000020	IW000025	IW000032	-	-	IW000040	-	IW000050	
	Size00	100kA	-	IW100004	IW100006	-	IW100010	IW100016	IW100020	IW100025	IW100032	-	-	IW100040	-	IW100050	
	Size0	80kA	-	-	-	-	-	-	-	-	-	-	-	-	-	-	
	Size01	80kA	-	-	-	-	-	-	-	-	IW001032	-	IW001036	-	-	IW001050	
	Size01	120kA	-	-	-	-	-	-	-	-	IW201032	-	IW201036	-	-	IW201050	
	Size1C	80kA	-	-	-	-	-	-	-	-	IW01C032	-	IW01C036	-	-	IW01C050	
	Size02	80kA	-	-	-	-	-	-	-	-	-	-	-	-	-	-	
	Size02C	80kA	-	-	-	-	-	-	-	-	-	-	-	-	-	-	
	Size03	80kA	-	-	-	-	-	-	-	-	-	-	-	-	-	-	
Cylindrical Type	FR-1 (14X51)	80kA	IFRH0002	IFRH0004	IFRH0006	-	IFRH0010	IFRH0016	IFRH0020	IFRH0025	IFRH0032	-	-	IFRH0040	IFRH0045	IFRH0050	
	FR-2 (22X58)	80kA	-	-	-	-	IFRH2010	-	IFRH2020	IFRH2025	IFRH2032	-	-	IFRH2040	IFRH2045	IFRH2050	
	FR-3 (30X57)	80kA	-	-	-	-	-	-	-	-	-	-	-	-	-	-	
	FR-4 (17X51)	80kA	-	-	-	-	-	-	-	-	-	-	-	-	IFRH4045	-	

# Technical Parameters

	60A	63A	80A	100A	125A	160A	200A	250A	300A	315A	355A	400A	425A	450A	500A	630A
	-	-	-	-	-	-	-	-	-	-	-	-	-	-	-	-
	-	-	-	-	-	-	-	-	-	-	-	-	-	-	-	-
	-	IEFSS063	-	-	-	-	-	-	-	-	-	-	-	-	-	-
	-	IEDCP063	IEDCP080	IEDCP100	IEDCP125	IEDCP160	-	-	-	-	-	-	-	-	-	-
	-	-	-	-	IESFP125	IESFP160	IESFP200	-	-	-	-	-	-	-	-	-
	-	IESDC063	IESDC080	IESDC100	IESDC125	-	-	-	-	-	-	-	-	-	-	-
	-	IHSDC063	IHSDC080	IHSDC100	-	-	-	-	-	-	-	-	-	-	-	-
	-	-	-	-	IEFSF125	IEFSF160	IEFSF200	IEFSF250	-	-	-	-	-	-	-	-
	-	-	-	-	-	-	-	IEFSK250	IEFSK300	IEFSK315	-	-	-	-	-	-
	-	-	-	-	-	-	-	IHFSK250	IHFSK300	IHFSK315	-	-	-	-	-	-
	-	-	-	-	-	-	-	-	-	-	IEFMF355	IEFMF400	-	-	-	-
	-	-	-	-	-	-	-	-	-	-	-	IEFTM400	-	-	IEFTM500	IEFTM630
	-	-	-	-	-	-	-	-	-	-	-	IEFTS400	-	IEFTS450	IEFTS500	IEFTS630
	-	IWS00063	-	-	-	-	-	-	-	-	-	-	-	-	-	-
	-	IW000063	IW000080	IW000100	IW000125	IW000160	-	-	-	-	-	-	-	-	-	-
	-	IW100063	IW100080	IW100100	IW100125	IW100160	-	-	-	-	-	-	-	-	-	-
	-	IW00063	-	IW00100	-	-	-	-	-	-	-	-	-	-	-	-
	-	IW001063	IW001080	IW001100	IW001125	IW001160	IW001200	IW001250	-	-	-	-	-	-	-	-
	-	IW201063	IW201080	IW201100	IW201125	IW201160	IW201200	IW201250	-	-	-	-	-	-	-	-
	-	IW01C063	IW01C080	IW01C100	IW01C125	IW01C160	-	-	-	-	-	-	-	-	-	-
	-	-	-	IW002100	IW002125	IW002160	IW002200	IW002250	-	IW002315	-	IW002400	-	-	-	-
	-	-	-	IW02C100	IW02C125	IW02C160	IW02C200	IW02C250	-	-	-	-	-	-	-	-
	-	-	-	-	-	-	-	-	-	IW003315	-	IW003400	IW003425	-	IW003500	IW003630
	IFRH0060	IFRH0063	-	-	-	-	-	-	-	-	-	-	-	-	-	-
	IFRH2060	IFRH2063	IFRH2080	IFRH2100	-	-	-	-	-	-	-	-	-	-	-	-
	-	-	IFRH3080	IFRH3100	-	-	-	-	-	-	-	-	-	-	-	-
	-	IFRH4063	-	-	-	-	-	-	-	-	-	-	-	-	-	-

## Switch Disconnecter Fuse (TPN/TPSN)

(DIN Type)

### Open Execution

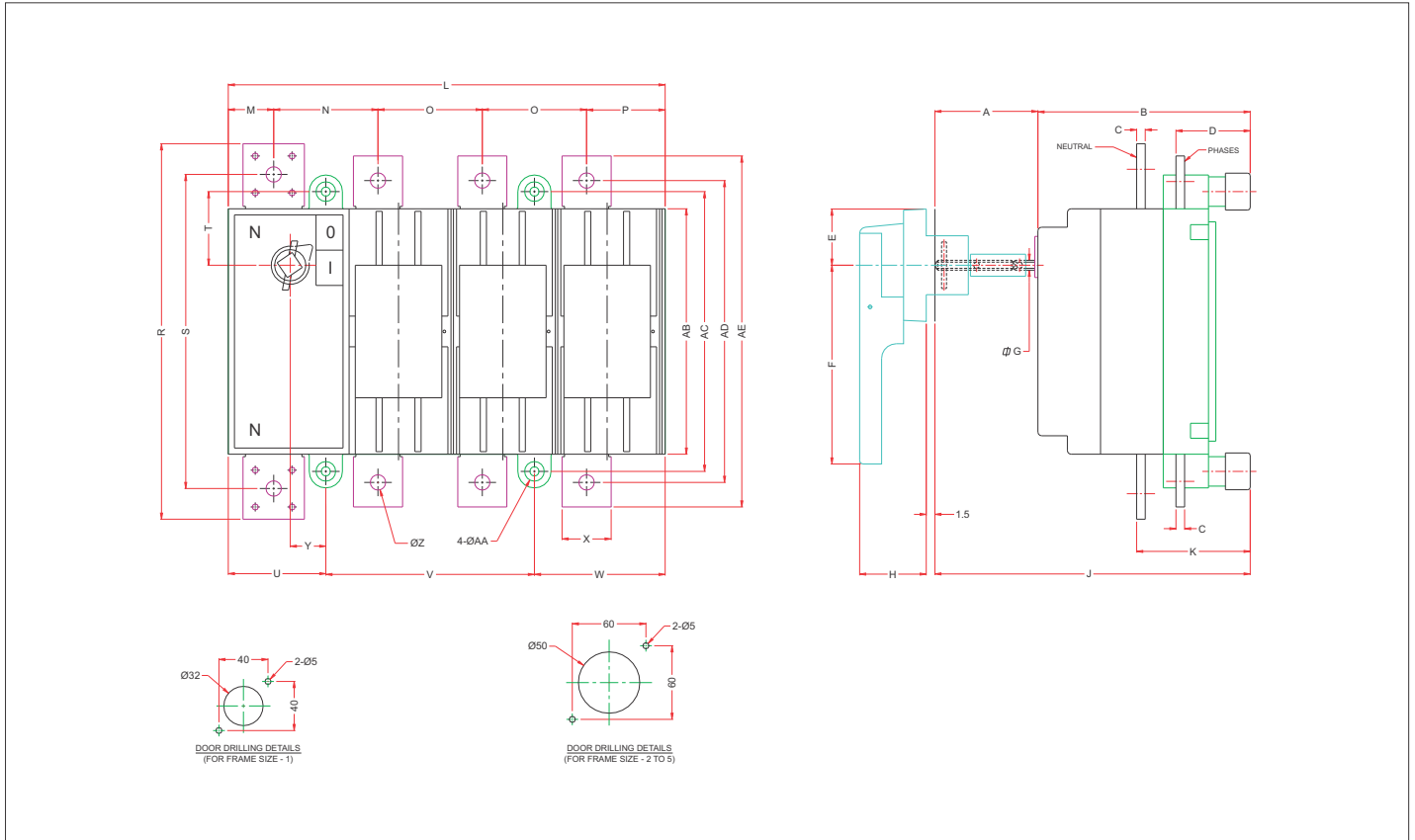

DIN TYPE for TPN / TPSN	A	B	C	D	E	F	G	H	J	K	L	M	N	O	P	R	S	T	U	V	W	X	Y	Z	AA	AB	AC	AD	AE	TPN		TPSN
																														Phase	Neutral	Terminal Size
																														Terminal Size	Terminal Size	Terminal Size
32A, 63A	92	96.5	2	31	33	64	8	39	189	31	142	19	33	33	24	105	95	23	35.5	66	40.5	12	14	Ø5.5	Ø9.5	77	88	95	105	12x2	12x1.6	15x3
100A, 125A, 160A	90	102	4	36.5	46	163	8	39	192	36.5	168	22.5	37.5	39	30	146	131	37.5	40.5	78	49.5	16	14.5	Ø8.5	Ø9.5	106	118	132	147	16x4	16x3	16x4
200A, 250A	90	121	4	41	46	163	10	55	211	56	235	29	56	56	38	196	171	47	53	114	68	25	21	Ø10.5	Ø12	140	157	168	207	25x4	25x3	28x4
315A, 400A	90	151	5	52	46	163	12	55	241	68	280	31.5	66.5	68	46	230	205	51	64	136	80	30	24	Ø12.5	Ø14.5	160	180	217	268	30x5	30x3	40x6
630	90	172	7	77	46	232	12	55	265	98	358	37	85	85	64	306	256	60	79.5	170	107	40	29	Ø12.5	Ø16	200	228	246	286	40x7	50x4	50x7

All dimensions are in mm. and Gen. Tol.  $\pm 1.5$ mm.

# Dimensions

## Switch Disconnecter Fuse (TPN/TPSN)

(Bolted Type)

### Open Execution

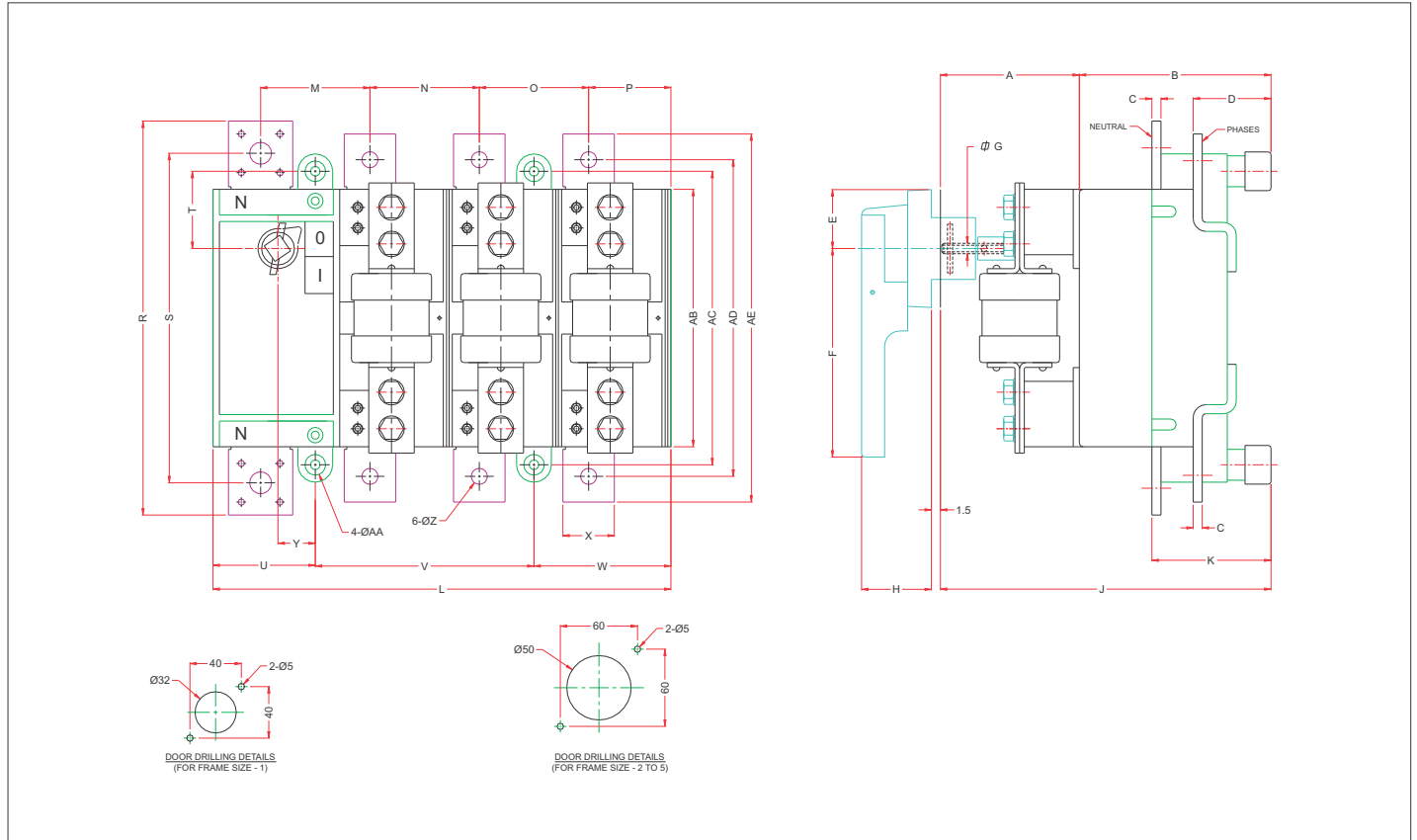

BOLTED TYPE for TPN / TPSN	A	B	C	D	E	F	G	H	J	K	L	M	N	O	P	R	S	T	U	V	W	X	Y	Z	AA	AB	AC	AD	AE	TPN		TPSN
																														Phase	Neutral	Terminal Size
																														Rating	Terminal Size	Terminal Size
32A, 63A	92	96.5	2	31	33	64	8	39	189	31	142	19	33	33	24	105	95	23	35.5	66	40.5	12	14	05.5	09.5	77	88	95	105	12x2	12x1.6	15x3
100A, 125A, 160A	90	102	4	36.5	46	163	8	39	192	36.5	168	22.5	37.5	39	30	146	131	37.5	40.5	78	49.5	16	14.5	08.5	09.5	106	118	132	147	16x4	16x3	16x4
200A, 250A	90	121	4	41	46	163	10	55	211	56	235	29	56	56	38	196	171	47	53	114	68	25	21	010.5	012	140	157	168	207	25x4	25x3	28x4
315A, 400A	90	151	5	52	46	163	12	55	241	68	280	31.5	66.5	68	46	230	205	51	64	136	80	30	24	012.5	014.5	160	180	217	268	30x5	30x3	40x6
630	90	172	7	77	46	232	12	55	265	98	358	37	85	85	64	306	256	60	79.5	170	107	40	29	012.5	016	200	228	246	286	40x7	50x4	50x7

All dimensions are in mm. and Gen. Tol. ± 1.5mm.

### Sheet Enclosure Execution

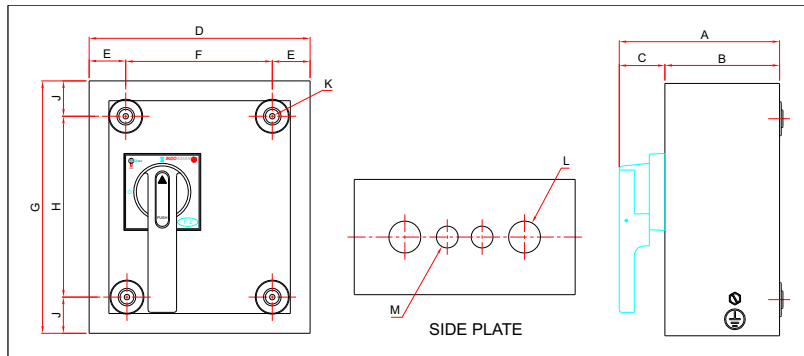

TYPE				A	B	C	D	E	F	G	H	J	K	L	M
DIN TYPE		BOLTED TYPE													
TPN	TPSN	TPN	TPSN												
IN1SA-32,63A	IN1SB-32,63A	INS1A-32,63A	INS1B-32,63A	229	190	39	260	33.5	193	270	140	65	Ø6-0	2-Ø38	2-Ø26
IN1SA-100,125,160A	IN1SB-100,125,160A	INS1A-100,125,160A	INS1B-100,125,160A	255	200	55	280	33.5	213	300	165	67.5	Ø6-0	2-Ø38	2-Ø26
IN1SA-200,250A	IN1SB-200,250A	INS1A-200,250A	INS1B-200,250A	275	220	55	346	43	260	350	212	69	Ø9-0	2-Ø52	2-Ø38
IN1SA-315,400A	IN1SB-315,400A	INS1A-315,400A	INS1B-315,400A	300	245	55	378	44.5	289	350	218	66	Ø9-0	4-Ø60	-
IN1SA-630,800A	IN1SB-630,800A	INS1A-630,800A	INS1B-630,800A	330	275	55	480	45	390	600	515	42.5	Ø6-0	-	4-Ø52

All dimensions are in mm. and Gen. Tol. ± 1.5mm.

### Switch Disconnectors

#### Open Execution

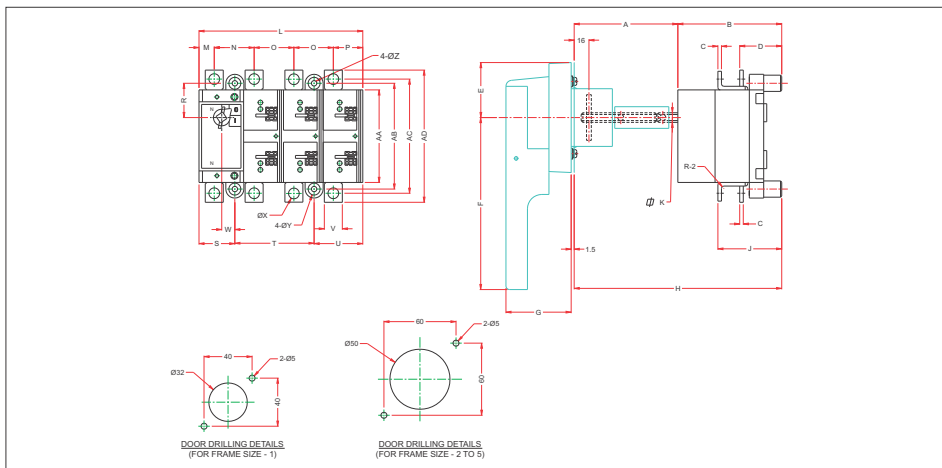

Size	A	B	C	D	E	F	G	H	J	K	L	M	N	O	P	R	S	T	U	V	W	X	Y	Z	AA	AB	AC	AD
IN1SD-63A,100A,125A	92	86	3	33	33	54	39	178	56	8	142	19	33	33	24	23	35.5	66	40.5	15	14	Ø8.5	Ø9.5	Ø4.5	77	88	118	138
IN1SD-200A,250A	90	94	4	41	46	163	55	184	41	8	168	13	45	45	22.5	37.5	40.5	78	49.5	20	14.5	Ø10.5	Ø9.5	Ø4.5	107	118	175	205
IN1SD-315A,400A	90	114	4	49	46	163	55	204	85	10	235	29	58	58	38	47	53	114	68	28	21	Ø12.5	Ø12	Ø6	140	157	217	270
IN1SD-630A	90	140.5	6	58	46	163	55	230.5	-	12	280	31.5	66.5	68	46	51	84	136	80	40	24	Ø12.5	Ø14.5	Ø7	160	180	246	300
IN1SD-800A	90	164	7	73.5	46	232	55	254	-	12	356	37	85	85	64	60	79.5	170	106.5	50	29	Ø16.5	Ø16	Ø7	200	228	256	306

All dimensions are in mm. and Gen. Tol. ± 1.5mm.

## Bolted Type HRC Fuse Links

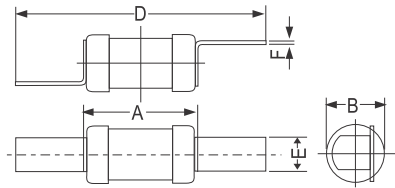

Ref. No.	Ref. As per IS:13703 / IEC 60269	A	B	D	E	F
FGN	F1	34	14.2	60	11	0.8

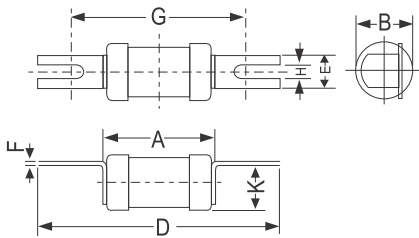

Ref. No.	Ref. As per IS:13703 / IEC 60269	A	B	D	E	F	G	H	K
FSS	A3	56	21.5	88.5	12.7	1.2	73	5.5	21.3

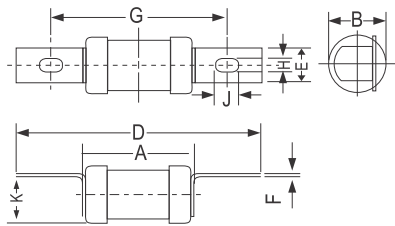

Ref. No.	Ref. As per IS:13703 / IEC 60269	A	B	D	E	F	G	H	J	K
FSA	A2	56	21.5	84.5	8.7	1.2	73	5.5	8	21.3
FSDCP	A4	65.7	31.8	110	17	2.65	94	8.7	10	30
FSFP	-	73	39.5	110	19	2.35	94	8.7	11	42

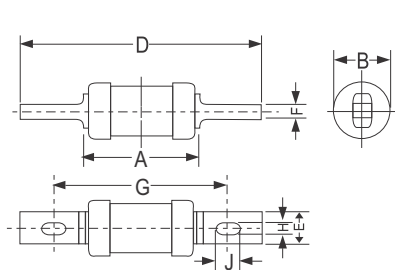

Ref. No.	Ref. As per IS:13703 / IEC 60269	A	B	D	E	F	G	H	J
FSDC	B1	65.7	31.8	136	17	3.2	111	8.7	11
FSF	B2	72	39.5	132	19	3.2	111	8.7	11
FSK	B3	70	50.5	136	25.4	3.2	111	8.7	11
FMF	B4	72	50.5	136	25.4	5.3	111	8.7	11
FTS	-	71	70	156	25.4	6.5	133	10.3	12.5

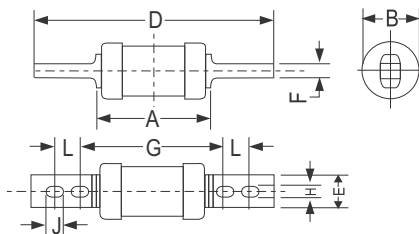

Ref. No.	Ref. As per IS:13703 / IEC 60269	A	B	D	E	F	G	H	J
FTM	C2	71	70	208	25.4	6.5	133	10.3	12.5

All dimensions are in mm. and Gen. Tol.  $\pm 1.5\text{mm}$ .

# Dimensions

## DIN Type HRC Fuse Links

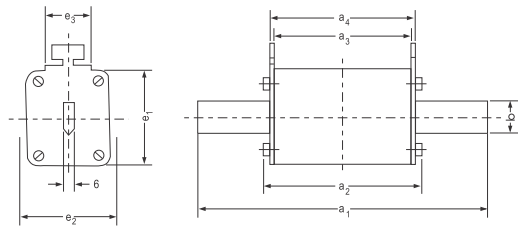

Type	Rated Current	a1	a2	a3	a4	b	e1	e2	e3
SIZE-000	6-63A	78.5	52.5	46	49.2	15	40	21	20
SIZE-00	6-160A	78.5	51.5	45	49	15	42	29	20.5
SIZE-0	63-100A	125	66.5	60.5	63.7	15	43	28	20
# SIZE- 1 (Compact)	32-160A	135	70	63	67	15	43	30	20
SIZE- 1 (Normal)	200-250A	135	70	62	65	20	46	46	22
# SIZE- 2 (Compact)	100-250A	150	70	63	67	20	48	46	22
SIZE- 2 (Normal)	315-400A	150	72	62	68	25	56	57	24
SIZE-3	315-630A	150	72	62	68	33	72	72	24

# Also available in normal size on request.

## Cylindrical Type HRC Fuse Links

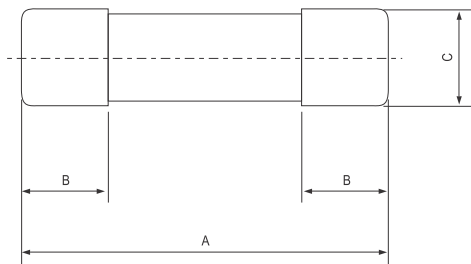

Type	Rating	A	B	C
FR1(14X51)	2 - 63A	51	10	14.3
FR2(22X58)	10 - 100A	57	16	22
FR3(30X57)	80 - 100A	57	16	30
FR4(17X51)	45 - 63A	51	12.5	17

## 'J' Type HRC Fuse Links

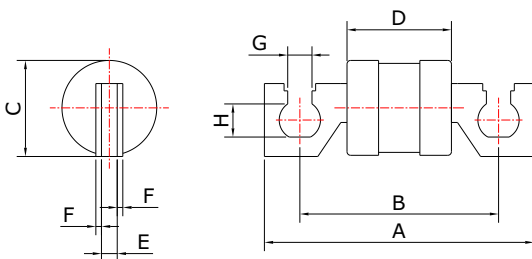

Type	Rating	A	B	C	D	E	F	G	H
SMJ-30	315A	111	82	39	44	6.5	2.3	17	14
SMJ-31	315A	127	92	39	41	8.1	3.2	20	17
SPJ-30	400A	111	82	50	44	6.5	2.3	17	14
SPJ-31	400A	127	92	50	41	8.1	3.2	20	17

All dimensions are in mm. and Gen. Tol.  $\pm 1.5\text{mm}$ .



## BS Type Fuse Base

### Technical & Performance Characteristics

Rating Amps	Type	List No.	Prefix Letters of Fuse Links Accomodated	A	B	C	D	E	F	G	H
20	Front Connection	OFCB015	FGN								
20	Bus Bar Type	OFCB015	FGN	25	81	42	5	67	5	-	-
32	Front Connection	OFCB032	FSA								
32	Bus Bar Type	OFCB032	FSA	33	101	65	6.3	76	6.5	44.5	12.5
63	Front Connection	OFCB063	FSS								
63	Bus Bar Type	OFCB063	FSS	35	105	70.5	8	71	6.5	45	12
100	Front Connection	OFCB100	FSDCP								
100	Bus Bar Type	OFCB100	FSDCP	49	131	93	12	92	22	54.5	19

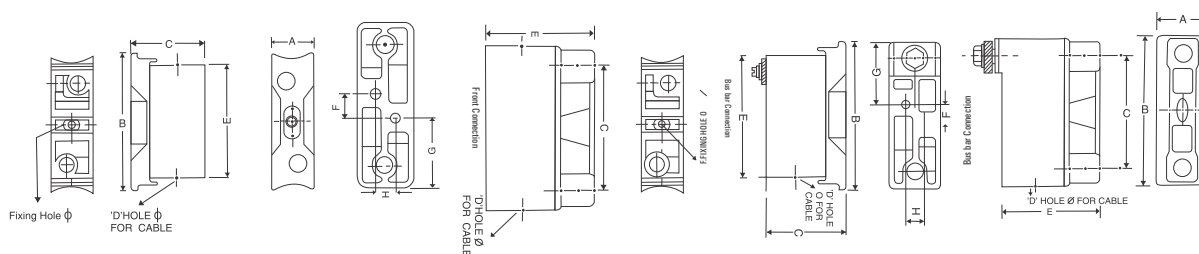

## DIN Type Fuse Base

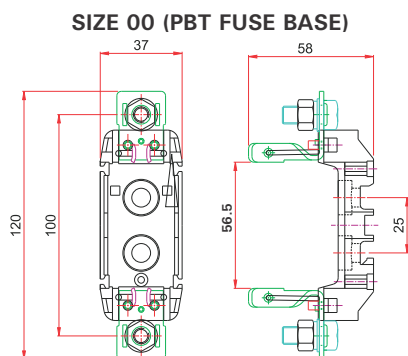

**(DMC FUSE BASE)**

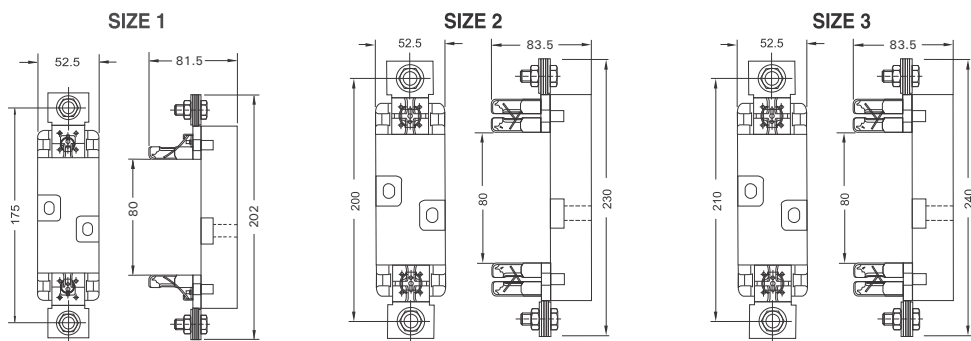

Rating	Type	DIN type fuse link Rating	Suitable for	Cat. Refs
1	DMC Fuse Holder	06A to 160A	Size 00	IWFB0***
2	DMC Fuse Holder	32A to 250A	Size 01	IWFB1***
3	DMC Fuse Holder	100A to 400A	Size 02	IWFB2***
4	DMC Fuse Holder	315A to 630A	Size 03	IWFB3***

\*mention required current rating (amperes)

All dimensions are in mm. and Gen. Tol. ± 1.5mm.

## Nomenclature of below mentioned ratings of HRC Fuses and HRC Fuse bases:-

### 1. Nomenclature Sheet:- HRC DIN type fuse links

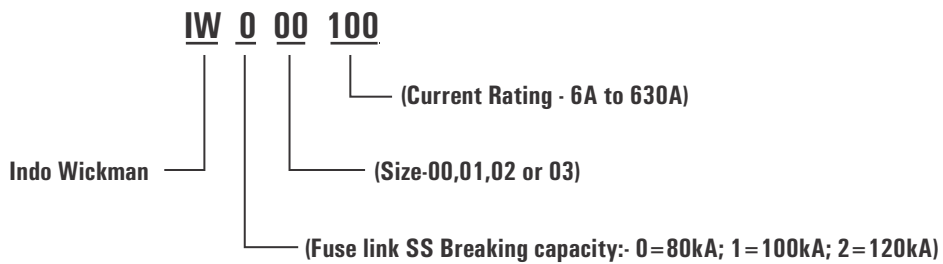

### 2. Nomenclature of Bolted type fuses:-

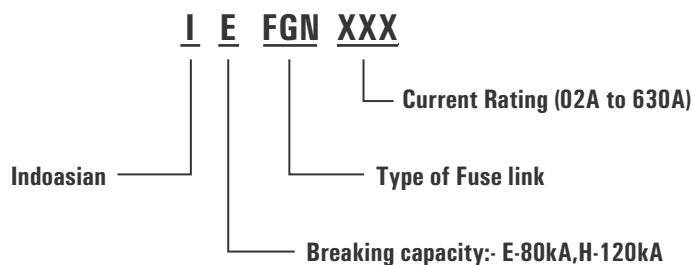

### 3. Nomenclature of Cylindrical type fuses:-

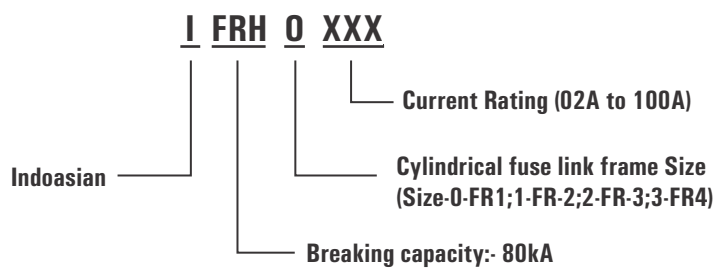

### 4. Nomenclature of fuse Base (DMC type):-

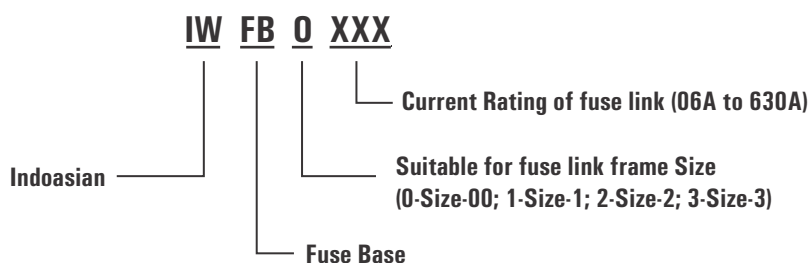

## List of HRC Fuse ratings used by M/s Delta Power Solution, are as under:-

S.no.	Product	Type and Rating	DELTA Description	DELTA Part no.
1	DIN type fuses	Size 00, 100A	FUSE gG P 100A 500V H BLADE	IW000100
2	DIN type fuses	Size 00, 125A	FUSE gG P 125A 500V H BLADE	IW000125
3	DIN type fuses	Size 00, 160A	FUSE gG P 160A 500V H BLADE	IW000160
4	DIN type fuses	Size 00, 80A	FUSE gG P 80A 500V H BLADE	IW000080
5	DIN type fuses	Size 00, 50A	FUSE gG P 50A 500V H BLADE NH00	IW000050
6	DIN type fuses	Size 00, 63A	FUSE gG P 63A 500V H BLADE NH00	IW000063
7	DIN type fuses	Size 01, 160A	FUSE gG P 160A 500V H BLADE	IW001160
8	DIN type fuses	Size 01, 125A	FUSE gG P 125A 500V H BLADE	IW001125
9	DIN type fuses	Size 01, 80A	FUSE gG P 80A 500V H BLADE	IW001080
10	DIN type fuses	Size 01, 200A	FUSE gG P 200A 500V H BLADE	IW001200
11	DIN type fuses	Size 01, 250A	FUSE gG P 250A 500V H BLADE	IW001250
12	DIN type fuses	Size 02, 315A	FUSE gG P 315A 500V H BLADE	IW002315
13	DIN type fuses	Size 02,400A	FUSE gG P 400A 500V H BLADE	IW002400
14	DIN type fuses	Size 03, 630A	FUSE gG P 630A 500V H BLADE	IW003630
15	DIN type fuses	Size 03, 500A	FUSE gG P 500A 500V H BLADE	IW003500
16	Cylindrical fuses	FR1 40A	FUSE C 40A 415V CLIP 14*51	IFRH0040
17	Bolted fuses	FSF 160A	FUSE P 160A 500V SCREW	IEFSF160
18	Bolted fuses	FSDC 100A	FUSE P 100A 500V SCREW	IESDC100
19	Fuses Holder	NA	Fuse Holder DMC Ag 250A	IWFB01DE/IWFB1250
20	Fuses Holder	NA	Fuse Holder DMC Ag 400A	IWFB02DE/IWFB2400
21	Fuses Holder	NA	Fuse Holder DMC Ag 630A	IWFB03DE/IWFB3630

\* FR series is for Domestic market & ZR series is for export market (Australia Continent only).

**CORPORATE OFFICE:** V. J. Business Towers, A-6, 1st Floor, Sector-125, Noida-201301, U.P., India. Ph.: +91-0120-3305100 E-mail: sales@indoasian.com, international@indoasian.com Website: www.indoasian.com

**CUSTOMER CARE SUPPORT EXECUTIVE:** V. J. Business Towers, A-6, 1st Floor, Sector-125, Noida-201301, U.P., India. Ph.: +91-0120-3305111 E-mail: feedback@indoasian.com

#### **NORTH**

**Regional Sales office**

**DELHI NCR**

V. J. Business Towers  
A-6, Ground Floor,  
Sector-125, Noida-201301

Ph.: 0120-3365300

E-Mail: in-delhi-office@indoasian.com

**Branch office**

**CHANDIGARH**

S.C.O.-11, 2nd Floor,  
Sector-26, Madhya Marg,  
Chandigarh-160002

Ph.: 0172-3934651

E-Mail: in-chandigarh-office@indoasian.com

**Branch office**

**JAIPUR**

433, 4th Floor, Ganpati Plaza,  
M. I. Road,  
Jaipur-302001

Ph.: 0141-4113528

E-Mail: in-jaipur-office@indoasian.com

**Branch office**

**LUCKNOW**

301, 3rd Floor, Chintel House,  
Station Road,  
Lucknow-226001

Ph.: 0522-4013210

E-Mail: in-lucknow-office@indoasian.com

#### **SOUTH**

**Regional Sales office**

**BANGALORE**

787, 1st Floor "Skyline Vista"  
15th Cross, 100 Feet Ring Road  
J P Nagar 1st Phase  
Bangalore-560 078

Tel: 080-46219999

E-Mail: in-bangalore-office@indoasian.com

**Branch office**

**COCHIN**

Door No.65/1317, Syda Building,  
2nd Floor, Kaloor-Kadavanthra Road,  
Kaloor, Ernakulam District,  
Kochi-682017 (Kerala)

Ph.: 0484-4055581-88

E-Mail: in-cochin-office@indoasian.com

**Branch office**

**COIMBATORE**

Door No. 83,  
Dr. Nanjappa Road,  
Coimbatore-641018

Ph.: 0422-2302715

E-Mail: in-coimbatore-office@indoasian.com

**Branch office**

**CHENNAI**

No.5, 1st Floor, Mahalingapuram Main Road,  
Nungambakkam,  
Chennai-600034

Ph.: 044-28172096, 28170527

E-Mail: in-chennai-office@indoasian.com

**Branch office**

**HYDERABAD**

312, 3rd Floor,  
Amrutha Estates, Himayath Nagar,  
Hyderabad-500029

Ph.: 040-66742425

E-Mail: in-secunderabad-office@indoasian.com

#### **WEST**

**Regional Sales office**

**MUMBAI**

401 & 408, K.P. Arrum,  
Marol Maroshi Road, Andheri East,  
Mumbai-400059

Ph.: 022-61035800

E-Mail: in-mumbai-office@indoasian.com

**Branch office**

**AHMEDABAD**

102, 1st Floor, Shivalik High Street,  
Near Mansi Circle, Vastrapur,  
Ahmedabad-380015

Ph.: 079-29701351-53

E-Mail: in-ahmedabad-office@indoasian.com

**Branch office**

**INDORE**

202, KK Bafna Arcade,  
Janjeerwala Square,  
Race Course Road,  
Indore-452001

Ph.: 0731-4064064

E-Mail: in-indore-office@indoasian.com

**Branch office**

**PUNE**

1307, 4th Floor, Rajadwar Building,  
Off. J. M. Road, Shivaji Nagar,  
Pune-411005

Ph.: 020-60500440

E-Mail: in-pune-office@indoasian.com

#### **EAST**

**Regional Sales office**

**KOLKATA**

"Raikva Building" Room No. 8, 2nd Floor,  
3A Ram Mohan Garden Lane,  
Beliaghata E.M.Bypass, Kolkata-700010

Ph.: 033-66041503

E-Mail: in-kolkata-office@indoasian.com